

- Digital control
- Compact design
- Operated by proportional solenoids
- High sensitivity and slight hysteresis
- Installation dimensions to DIN 24 340 / ISO 4401 / CETOP RP121-H

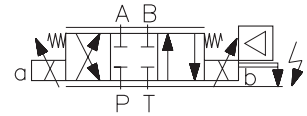
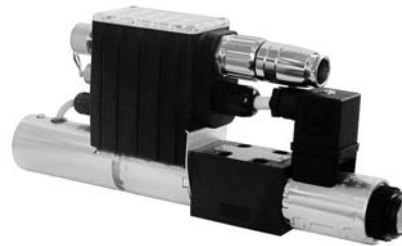

Functional Description

The proportional directional valve PRM7 consists of a cast iron housing, a special control spool, two centering springs with supporting washers, one or two proportional solenoids, a position sensor or, if need be, of a control box with digital electronics.

The measuring system of the position sensor consists of a differential transformer with core and from the evaluating electronic unit realized in hybrid technique.

With the model without integrated electronic unit, the electric connection of the solenoids is realized by the connector plug to EN 175301-803, with the position sensor output being connected by the G4W1F connector plug. Both connectors are supplied.

The proportional valve with the integrated electronic unit comprises an electronic control box that is mounted, together with the position sensor, on either of the solenoids. The connection of the position sensor with the control box is provided by a cable. With the model with two solenoids, the solenoid mounted opposite the control box is connected with the control box by means of a EN 175301-803, connector. The connection of the supply voltage, control signal, program input and external output of the position sensor is realized by a 5-pin connector (ELKA 5012). The connection of the external feedback is provided by a 5-pin connector, which also has three supply voltages +24 V, +10V and -5V for an external sensor available. The solenoid coils, including the control box, can be turned in a range of $\pm 90^\circ$. The digital control unit enables the proportional valve to be controlled on the basis of data required from two feedback circuits.

In this case the proportional valve can be used as follows:

1. Proportional directional valve
2. Only with the internal feedback from the spool position sensor.
3. Only with the external feedback (pressure sensor, position sensor, etc.).
4. With internal and external feedback.

The outlet current to the electromagnet coils is controlled with the help of PWM. The electronic system is equipped with an internal current feedback. The outlet current in case of need may be modulated with the use of a signal of dynamic lubrication. Single function parameters are set up with the use of appropriate software with the help of a computer connected to the proportional switchboard through a serial interface RS 232.

It is necessary to order a cable in accordance with appropriate ordering number as mentioned on page 4.

The digital control unit utilizes the pulse-width-modulation (PWM) and supplies the solenoids with current proportional to the control signal. The supply current is additionally modulated with a dither frequency. The individual functional parameters are adjusted through software by means of a special programmer, or by means of a computer through the RS 232 interface. The correct function of the digital control unit is signaled by a green LED. The incorrect function (failure) is indicated by a red LED.

As a standard, the proportional valve is delivered with factory setting. The model including also an external feedback shall be consulted with the manufacturer.

With the basic surface treatment, the valve housing is phosphate coated, whereas the surfaces of the solenoids are zinc coated.

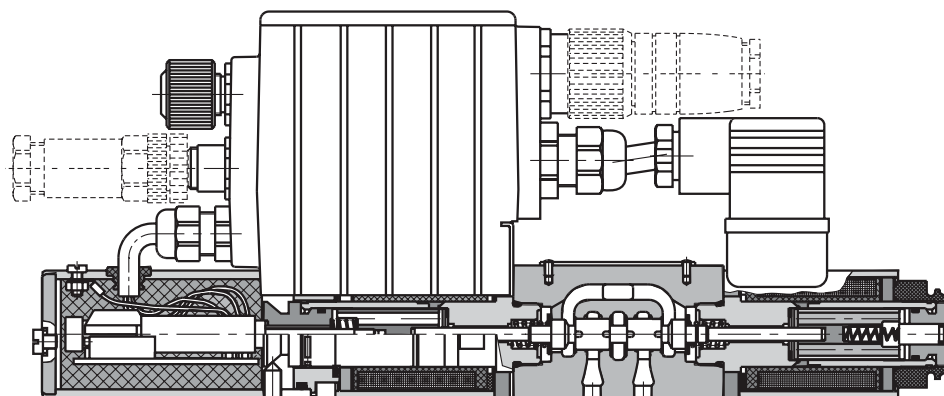

Ordering Code

PRM7-04 / -

Proportional Directional Control Valve

Seals

without designation
V

NBR
FPM (Viton)

Nominal size 04 (D 02)

Model

- S01** position sensor with voltage outlet
- S02** position sensor with current outlet
- E01** proportional directional valve without feedback
- E02S01** proportional directional valve with position feedback
- E03** proportional directional valve with external feedback
- E04S01** proportional directional valve with position and external feedback

Spool Symbols

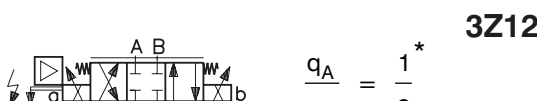

$$\frac{q_A}{q_B} = \frac{1}{2}^*$$



$$\frac{q_A}{q_B} = \frac{1}{2}^*$$

Nominal solenoid supply voltage

- 12** **supply voltage 12 V DC
- 24** supply voltage 24 V DC

** Cannot be supplied as Variant S2

Nominal flow rate at Δp = 145 PSI (10 bar)

- 4** flow 4 L/min (1.1 GPM)
- 8** flow 8 L/min (2.1 GPM)
- 12** flow 12 L/min (3.2 GPM)

* Model for cylinders with asymmetric piston rod, piston area ratio 1:2

Connectors are to be ordered **separately**, see ordering number on page 10

Technical Data		
Nominal size	mm (US)	04 (D 02)
Max. operating pressure at ports P, A, B	bar (PSI)	320 (4600)
Max. operating pressure at port T	bar (PSI)	210 (3046)
Hydraulic fluid		Hydraulic oils of power classes (HL, HLP) to DIN 51524
Fluid temperature range (NBR / Viton)	°C (°F)	-30 ... +80 (-22 ... +176) / -20 ... +80 (-4 ... +176)
Ambient temperature max.	°C (°F)	+50 (+122)
Viscosity range	mm ² /s (SUS)	20 ... 400 (98 ... 1840)
Maximum degree of fluid contamination		Class 21/18/15 to ISO 4406 (1999)
Nominal flow at $\Delta p = 10$ bar (145 PSI)	L/min (GPM)	4 (1.1) / 8 (2.1) / 12 (3.2)
Hysteresis - open loop	%	< 6
Hysteresis - closed position loop	%	< 0.5
Weight - PRM7-042 - PRM7-043	kg (lbs)	1.5 (3.30) 1.8 (3.96)
Mounting position		optional
Enclosure type to EN 60529		IP65

Technical Data of Position Sensor - Voltage Outlet

Operating pressure	bar (PSI)	max. 320 (4600), static
Electric connection		electrical connector G4W1F Hirschmann *
Contact assignment		1 - Power supply 2 - Command signal 3 - GND 4 - not used
Enclosure type to EN 60529		IP65
Measured distance	mm (in)	8 (0.315)
Operating voltage	V	9.6 ...30 DC
Linearity error	%	< 1
Current consumption at load current of 2 mA	mA	< 15
Output voltage	V	0 ... 5
Output signal range used: 0 Position 1 solenoid - stroke 1.8 mm (0.07 in) 2 solenoids - stroke ± 1.8 mm (0.07 in)	V	2.5 0.375 - 2.5 0.375 - 3.625
Max. load current	mA	2
Noise voltage - at load current 0 - at load current of 2 mA	mV _{p-p}	< 20 < 15
Additional output signal error at: Temperature change between 0 ... 80 °C (32 ...176 °F) Between 0 ... -25 °C (32 ...-13 °F) Load change from 0 to 2 mA		typical < 0.2% / 10K max. 0.5% / 10K max. 0.5% / 10K 0.1%
Input voltage change from 9.6 V to 14.4 V from 14.4 V to 30 V	%	< 0.1 < 0.25
Long-term drift (30 days)	%	< 0.25
Cut-off frequency 3 dB fall in amplitude Frequency 90°	Hz	> 600 > 600

* Only for S01 and S02 model.

Technical Data of Position Sensor - Current Outlet

Linearity	%	< 1
Operating pressure	bar (PSI)	to 320 (4600), static
Electrical connection		electrical connector G4W1F Hirschmann *
Contact assignment		1 - Power supply 2 - Command signal 3 - GND 4 - not used
Enclosure type to EN 60529		IP65
Operatin voltage	V	20 ... 30 DC
Current	mA	< 35
Output signal range	mA	4 20
Output signal range used: 0 position 1 solenoid -stroke 1.8 mm (0.07 in) 2 solenoids - stroke ± 1.8 mm (0.07 in)	mA	12 8.4 ... 12 8.4 ... 15.6
Additional output signal error: - at temperature change from +10 ... 55 °C (50 ...131 °F) - at impedance change from 50% - at input voltage change in the range of operating voltage		0.2% / 10K ≤ 0.1% ≤ 0.05%
Impedance	Ω	≤ 500
Output signal ripple	mA R.M.S.	≤ 0.02
Limit frequency at 3 dB amplitude decrease	Hz	≥ 800

* Only for S01 and S02 model.

Technical Data of Proportional Solenoid

Type of coil	V	12 DC	24 DC
Limiting current	A	1.7	0.8
Resistance at 20 °C (68 °F)	Ω	4.9	21

Electronics Data

Supply voltage with polarity inversion protection	V	11.2 ... 28 VDC (residual ripple < 10%)
Input: command signal / according to customer setting		±10V, 0 ... 10V, ±10mA, 4...20mA, 0...20mA, 12mA ± 8mA
Input: spool position sensor signal		0...5V
Input: external feedback signal		0...10V, 4...20mA, 0...20mA,
Resolution of the A/D converter		12 bit
Output: solenoids		Two PWM output stages up to max. 3.5 A
PWM frequency	kHz	18
Adjustment of parameters	μs	170
EMC	Interference resistance	61000 - 6 - 2 : 2005
	Radiation resistance	55011 : 1998 class A

Parameter setting	Serial port RS 232 (zero modem). 19200 bauds, 8 data bits, 1 stop bit, no parity. Special software PRM7Conf.
-------------------	---

Accessories

Order number	Content
566-9500	Connecting cable to PC - length 2m (6.56ft), CD-ROM with program PRM7Conf and user manual.
566-9501	Connecting cable to PC - length 5m (16.40ft), CD-ROM with program PRM7Conf and user manual.
566-9502	Connecting cable to PC - length size 2m (6.56ft).
566-9503	Connecting cable to PC - length size 5m (16.40ft).

Limit Power

Measured at $v = 32 \text{ mm}^2/\text{s}$ (156 SUS)

Only for E01 model

$P \rightarrow A / B \rightarrow T$ or $P \rightarrow B / A \rightarrow T$

Nominal flow 4 L/min (1.1 GPM)

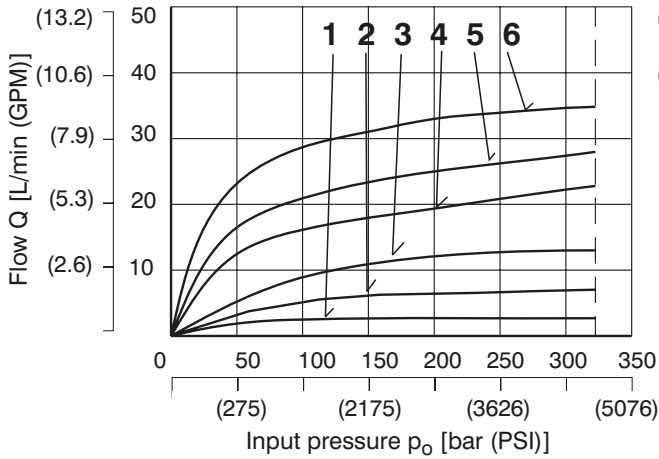

Nominal flow 8 L/min (2.1 GPM)

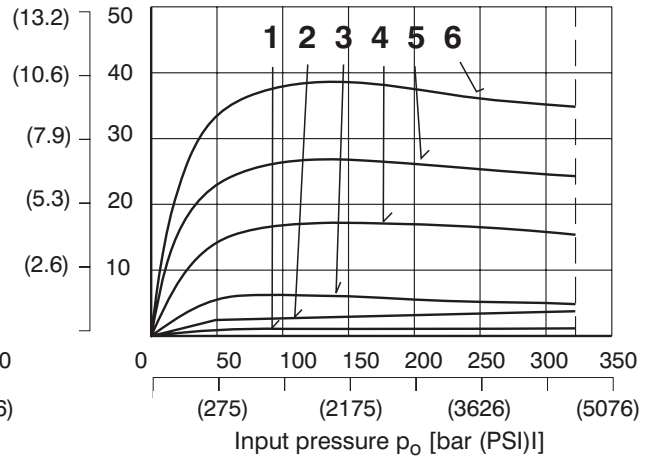

Nominal flow 12 L/min (3.2 GPM)

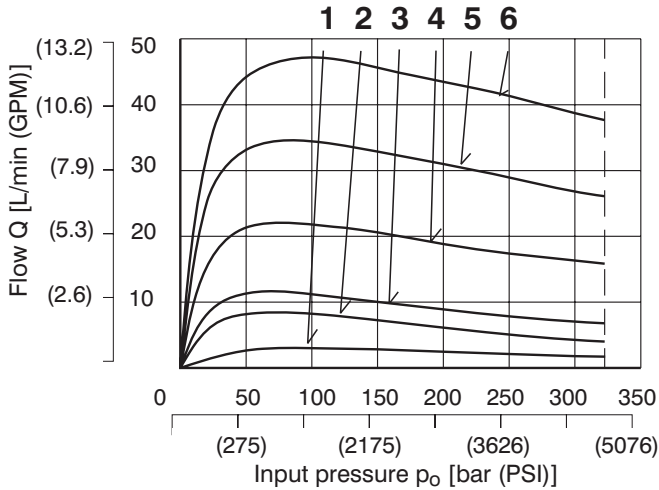

Solenoid current:

- 1 = 50%
- 2 = 60%
- 3 = 70%
- 4 = 80%
- 5 = 90%
- 6 = 100%

Flow Characteristics

Measured at input pressure $\Delta p = 10 \text{ bar}$ (145 PSI), $v = 32 \text{ mm}^2/\text{s}$ (156 SUS)

Only for E01 model

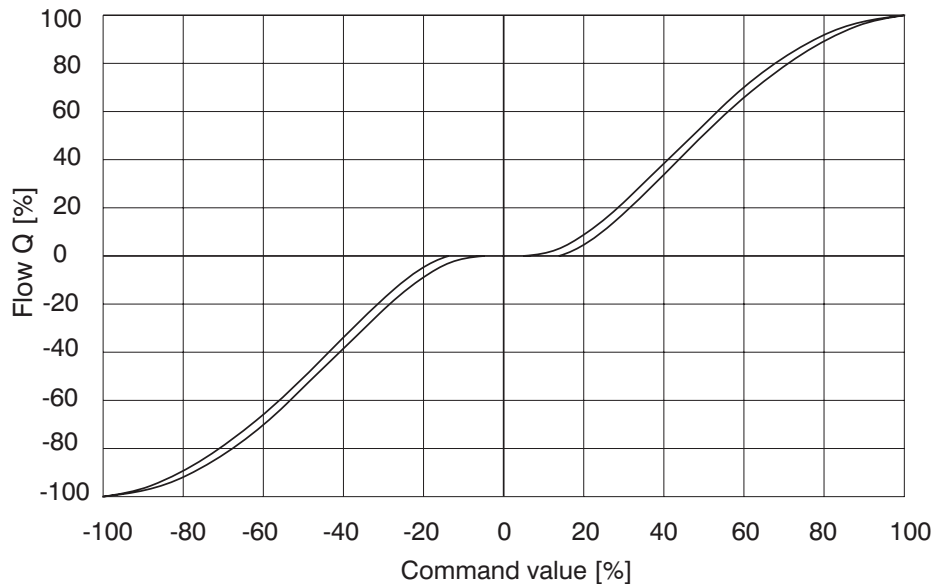

Flow Characteristics

Measured at $v = 32 \text{ mm}^2/\text{s}$ (156 SUS)

Only for E02S01 model

$Q_n = 4 \text{ L/min}$ (1.1 GPM) by $\Delta p = 10 \text{ bar}$ (145 PSI)

Δp = Valve pressure differential (inlet pressure p_V minus load pressure and return pressure p_T)

Δp_n = Valve pressure differential for nominal flow Q_n

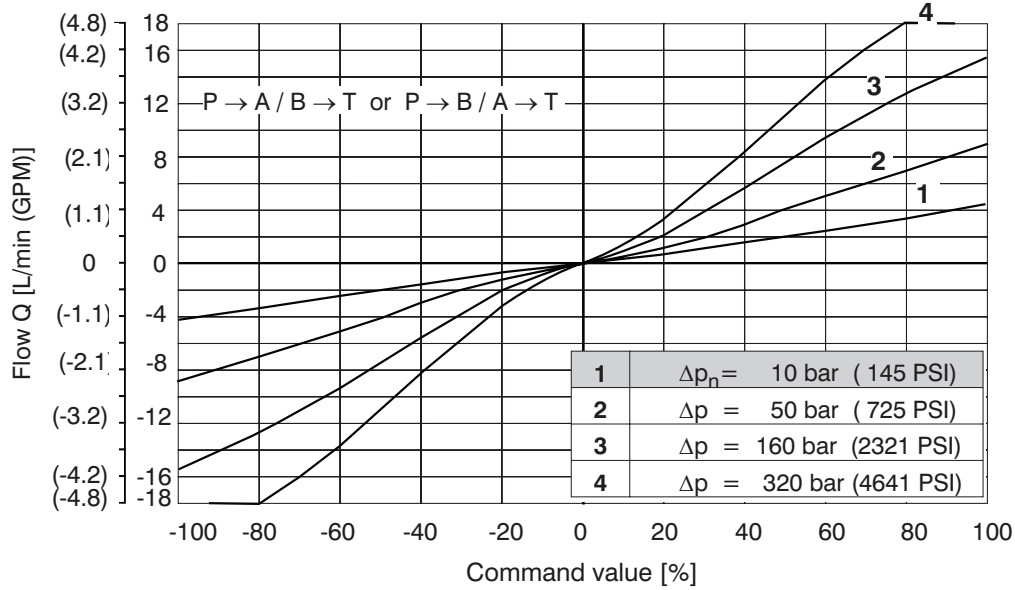

Only for E02S01 model

$Q_n = 8 \text{ L/min}$ (2.1 GPM) by $\Delta p = 10 \text{ bar}$ (145 PSI)

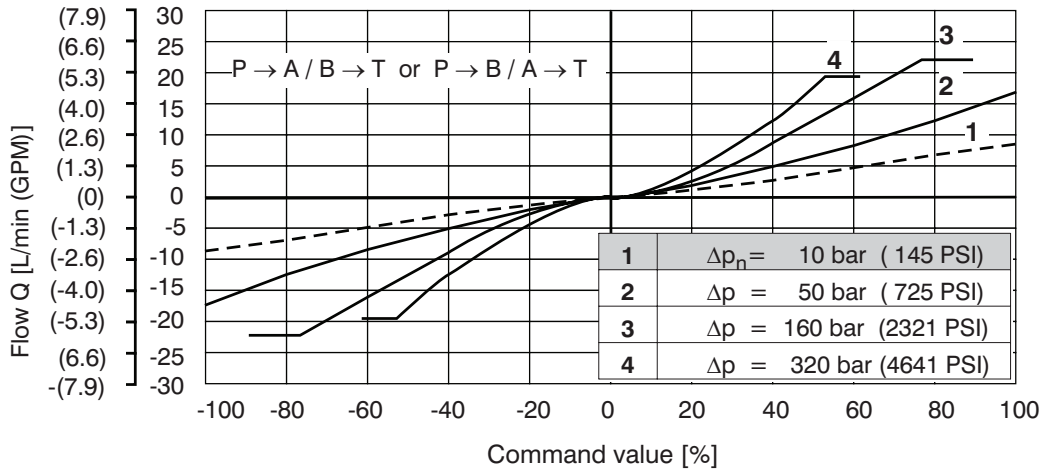

Only for E02S01 model

$Q_n = 12 \text{ L/min}$ (3.2 GPM) by $\Delta p = 10 \text{ bar}$ (145 PSI)

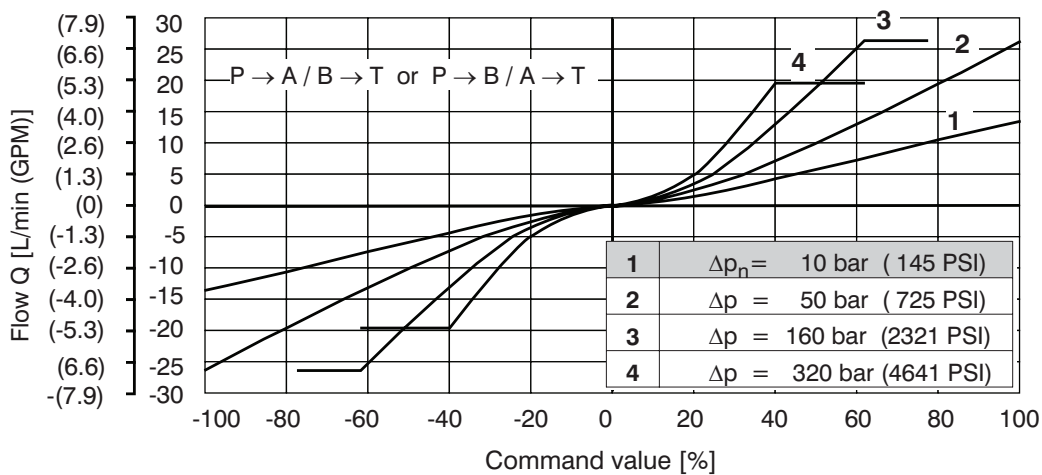

Frequency Reponse

closed position loop, for E02S01 model

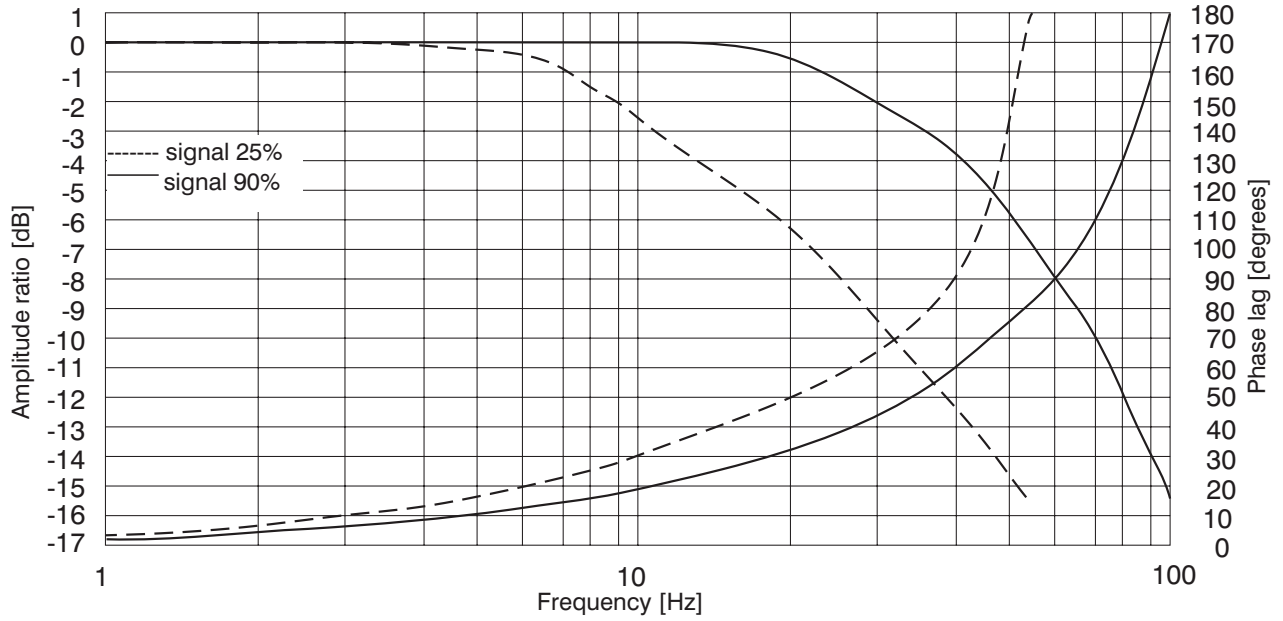

Connector Connection

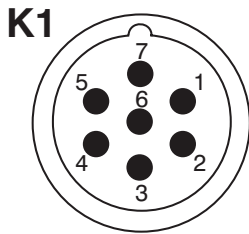

Connector K1- type M23 (male)		
PIN	Technical data	Description
1	* Power supply input	11.2 28V DC
2	* Ground (power supply)	0V
3	Control signal	according to configuration
4	Ground (signal)	0V
5	Power reference signal	+10V DC/max.10mA
6	Control signal of position sensor spool	0 ...5V
7	* Protection earth lead (PE)	---

* Recommended min. lead cross section 0.75mm²

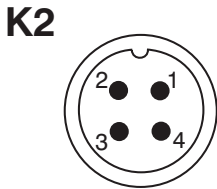

Connector K2 - type M12x1 (male)		
PIN	Technical data	Description
1	TxD	standard
2	RxD	RS 232
3	Ground (signal)	0V
4	Not used	

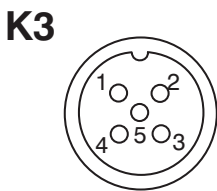

Connector K3 - type M12x1 (female)		
PIN	Technical data	Description
1	Power supply output	11.2 28V DC/max.100mA
2	Signal of external feedback	according to configuration
3	Ground	0V
4	Not used	
5	Not used	

K2 - Connection RS232 M12x1 (4 PIN)
For programming the electronics.

K1 - Main input connector M23 (7PIN)
Cable diameter 8 ...12mm (0.31...0.47in).

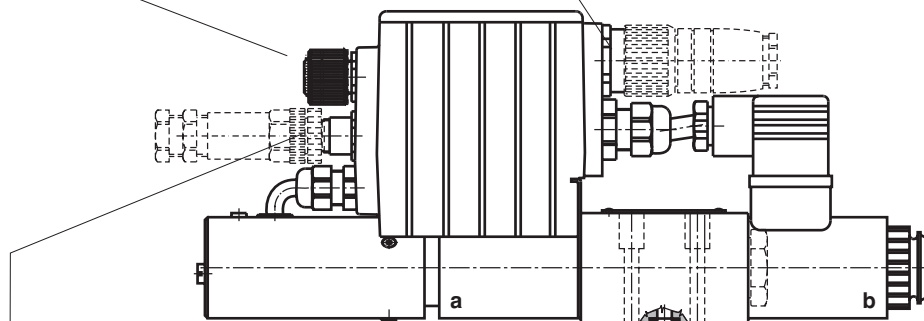

K3 - Conektor M12x1 (5PIN)
External feedback signal (it presented only for E03 and E04S01configurations).

Factory Settings

Item	Model							
	E01		E02S01		E03		E04S01	
	1 Magnet	2 Magnet	1 Magnet	2 Magnet	1 Magnet	2 Magnet	1 Magnet	2 Magnet
Control signal	0...10 V	± 10 V	0...10 V	± 10 V	0...10 V	± 10 V	0...10V	± 10 V
Signal external feedback	-	-	-	-	0...10 V			
Output position sensor spool	-	-	0...5 V		-	0...5 V		

Valve Dimensions

Dimensions in millimeters and inches

043 ... S01
043 ... S02

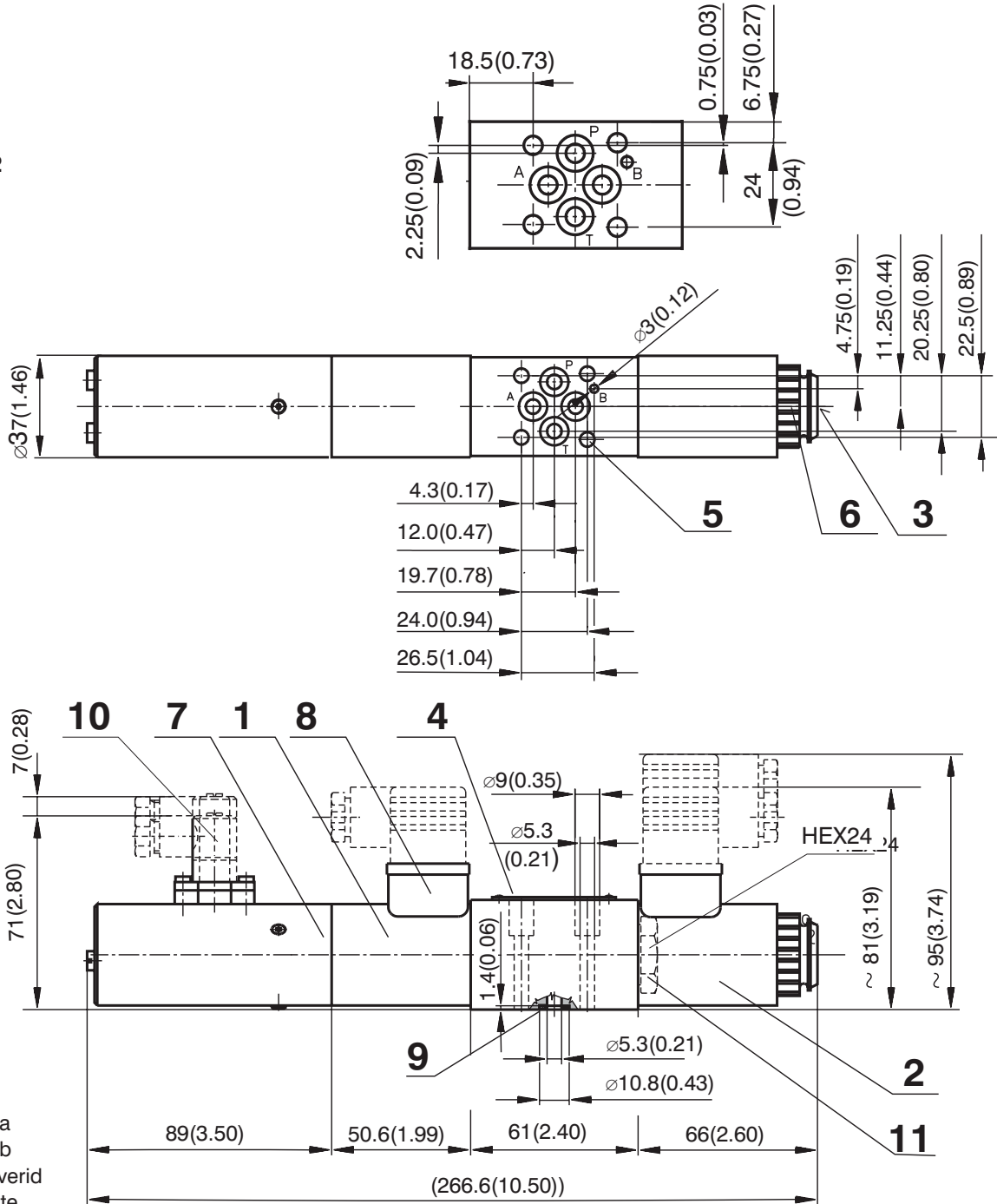

- 1 Solenoid a
- 2 Solenoid b
- 3 Manual overrid
- 4 Name plate
- 5 4 mounting holes
- 6 Solenoid fixing nut
- 7 Position sensor
- 8 Solenoid supply connector
- 9 Square ring 7.65 x 1.68 (4 pcs.), supplied in delivery packet
- 10 Position sensor connector
- 11 Plug screw for valve with one solenoid, HEX 24, configurations 2Z51, 2Z11

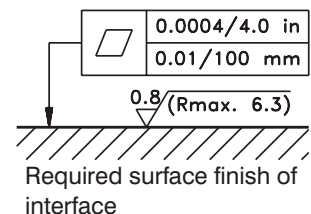

Valve Dimensions

Dimensions in millimeters and inches

043 ... E01 - without connector plug for spool position feedback

043 ... E03

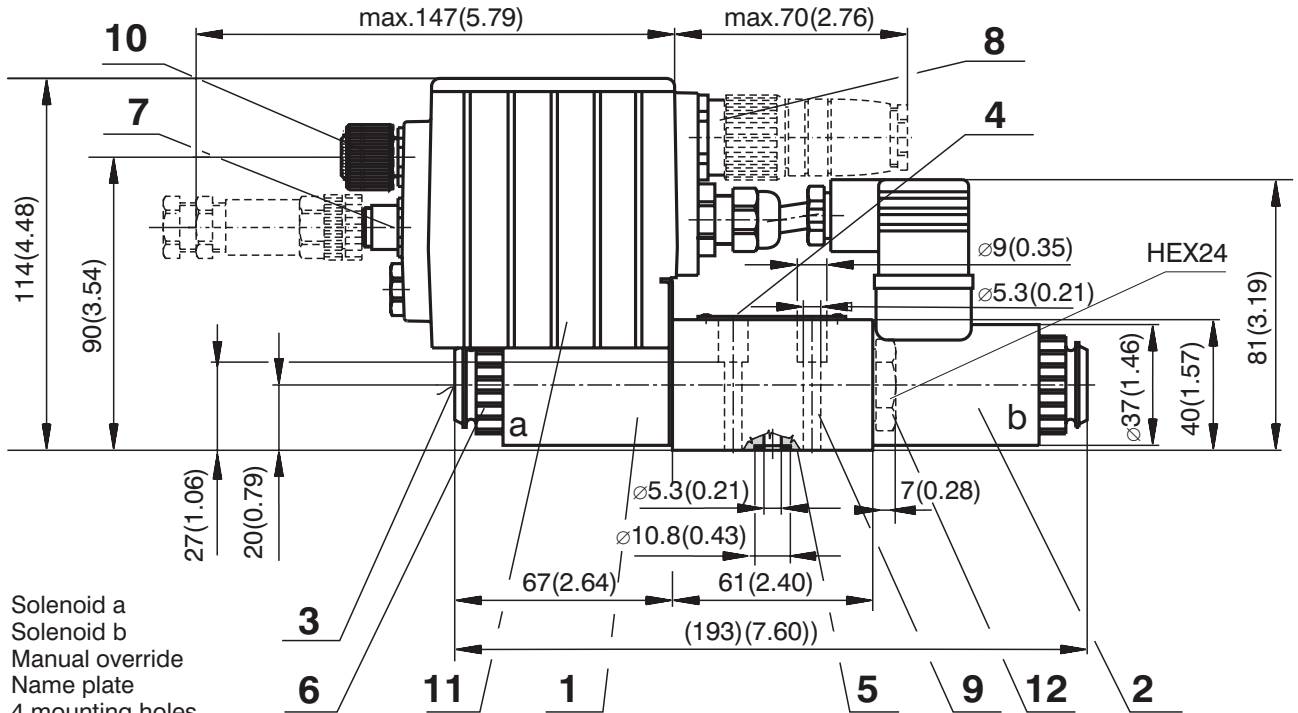

- 1 Solenoid a
- 2 Solenoid b
- 3 Manual override
- 4 Name plate
- 5 4 mounting holes
- 6 Solenoid fixing nut
- 7 Connector M12x1 for connection of external feedback
- 8 Main supply connector M23
- 9 Square ring 7.65 x 1.68 (4 pcs.), supplied in delivery packet
- 10 Cover of connector M12x1 for programming
- 11 Plastic box with integrated electronics
- 12 Plug screw for valve with one solenoid, HEX24, configurations 2Z51, 2Z11

043 ... E02S01 - without connector plug for spool position feedback

043 ... E04S01

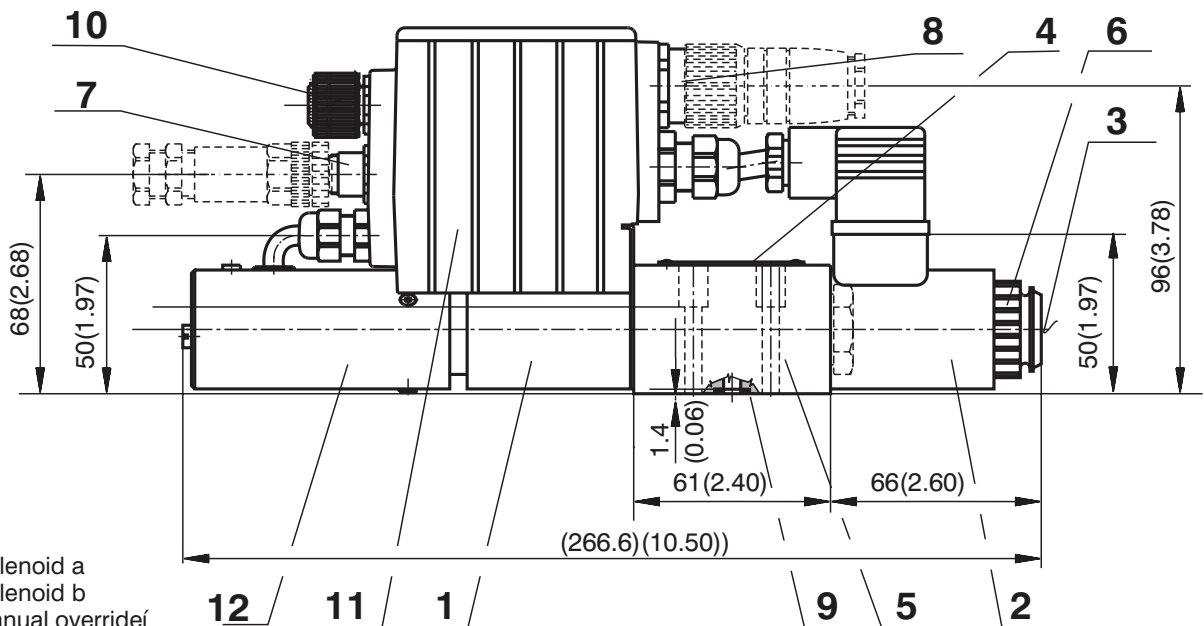

- 1 Solenoid a
- 2 Solenoid b
- 3 Manual override
- 4 Name plate
- 5 4 mounting holes
- 6 Solenoid fixing nut
- 7 Connector M12x1 for connection of external feedback
- 8 Main supply connector M23
- 9 Square ring 7.65 x 1.68 (4 pcs.), supplied in delivery packet
- 10 Cover of connector M12x1 for programming
- 11 Plastic box with integrated electronics
- 12 Position sensor

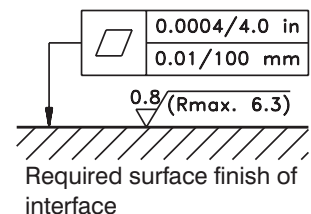

Spare Parts

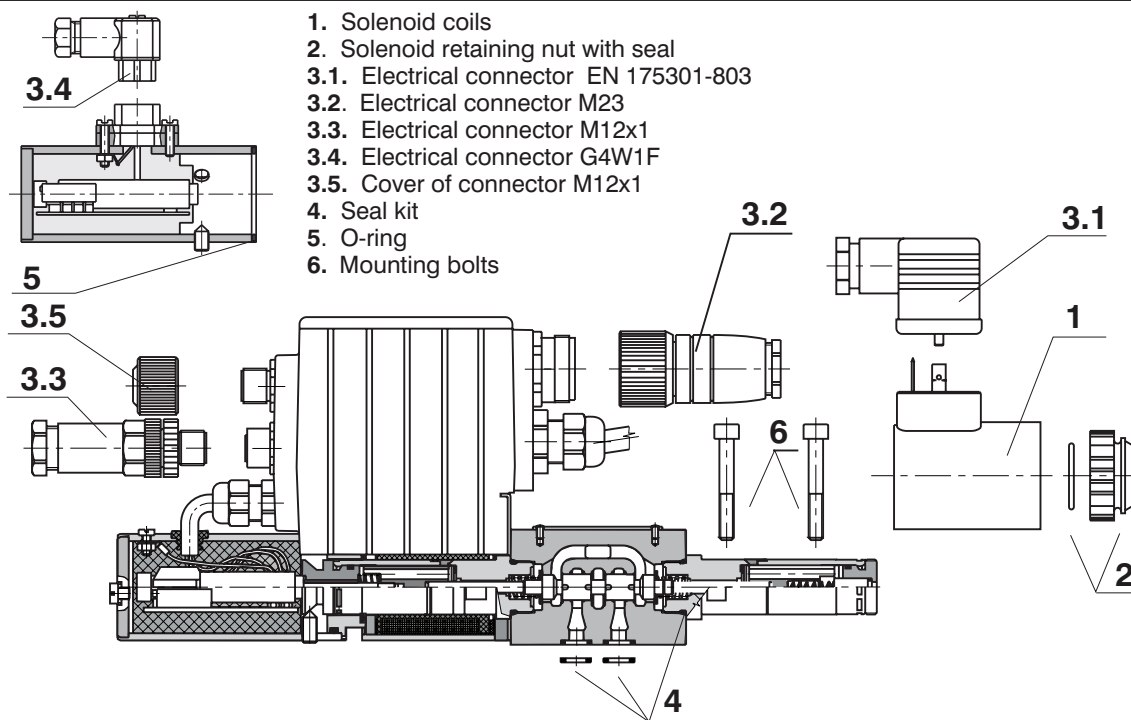

1. Solenoid coil

Solenoid type	Ordering number
01200	936-0033
02400	936-0034

2. Solenoid retaining nut with seal

Type of the nut	Seal ring	Ordering number
Standard nut	18 x 1.5	486-9010

3.1. Electrical connector EN 175301-803

Type designation	Type	Maximum input voltage	Connector A	Connector B
			grey	black
			Ordering number	
K5	without rectifier - M16x1.5 (bushing bore \varnothing 4-6 mm)	230 V DC	936-9906	936-9905

3.2. Electrical connector M23 - 7PIN (female)

Ordering number	345579500001
-----------------	--------------

3.3. Electrical connector M12x1- 5PIN (male), it presented only for E03 and E04S01 configurations

Ordering number	358359000002
-----------------	--------------

3.4. Electrical connector G4W1F

Ordering number	358358932157
-----------------	--------------

3.5. Cover of connector M12x1

Ordering number	566-7400
-----------------	----------

4. Seal kit

Type	Dimensions, number		Order number
	Square ring	O-ring	
Standard - NBR70	7.65 x 1.68 (4 pcs.)	16 x 1.8 (2 pcs.)	486-9002
Viton	7.65 x 1.68 (4 pcs.)	16 x 2.0 (2 pcs.)	486-9009

5. O-ring

Standard - NBR70	28 x 2 (1 pc.)	273111014120
------------------	----------------	--------------

6. Mounting bolts

Dimensions, number	Tightening torque	Ordering number
M5 x 35 DIN 912-10.9 (4 pcs.)	5 Nm (3.7 ft-lbs)	486-9011

Caution!

- The packing foil is recyclable. The protective plate can be returned to manufacturer.
- The technical information regarding the product presented in this catalogue is for descriptive purposes only. It should not be construed in any case as a guaranteed representation of the product properties in the sense of the law.

ARGO-HYTOS s.r.o, CZ - 543 15 Vrchlaví
 Tel.: +420-499-403111, Fax: +420-499-403421
 E-mail: sales.cz@argo-hytos.com
 www.argo-hytos.com